

SPEED BOX



Cassetti e cassettoni in alluminio premontati e completi per mobili
Complete, pre-assembled shallow and deep aluminium drawers for furniture units
Tiroirs et tiroirs profonds en aluminium pré montés et complets pour meubles
Cajones grandes y pequeños de aluminio premontados y completos para muebles
Vormontierte, komplette Schubläden und Schubkästen aus Aluminium für Möbel



FISSAGGIO DEI GANCI SULL'ANTA

ATTACHING HOOKS ON FLAP

FIXATION DES CROCHETS SUR LA PORTE

FIJACIÓN DE LOS GANCHOS EN LA HOJA

BEFESTIGUNG DER HAKEN AN DER TÜR

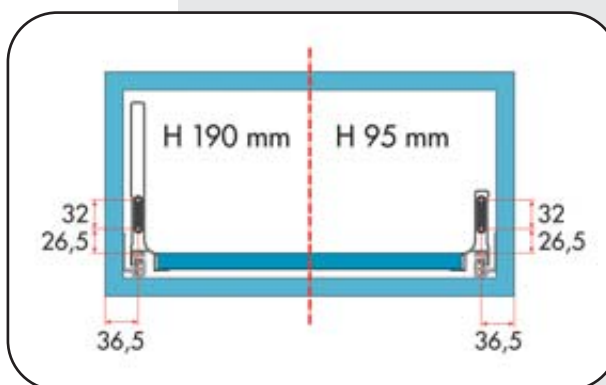

POSIZIONE FORATURA PER FISSAGGIO GUIDE

POSITION OF BORE HOLE TO ATTACH RUNNERS

POSITION PERÇAGE POUR FIXATION GLISSIERES

POSICIÓN DE LOS ORIFICIOS PARA FIJACIÓN DE LAS GUÍAS

POSITION BOHRUNG FÜR BEFESTIGUNG DER FÜHRUNG

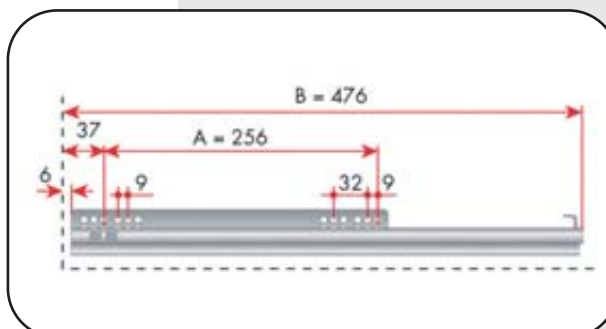

Cassetti H 95 mm

- Guide con autorientro ammortizzato
- Portata guide: 30 kg
- Cassetto tre lati in alluminio anodizzato con fondo in nobilitato color grigio argento

H 95 mm drawers

- Runners with dampened self-closing mechanism
- Runner capacity: 30 kg
- Drawer with three sides in anodised aluminium with silver-grey coloured metal bottom

Tiroirs H 95 mm

- Glissières à retour automatique amorti
- Portée des glissières: 30 kg
- Tiroir trois côtés en aluminium anodisé avec fond en panneau anoblí couleur gris d'argent

Cajones H 95 mm

- Guías con retorno automático amortiguado
- Capacidad de las guías: 30 kg
- Cajón con tres lados de aluminio anodizado y fondo de tablero atamborado de color plateado

Schubladen H 95 mm

- Führungsschienen mit gedämpfem Selbststeinzug
- Tragkraft der Führungen: 30 kg
- Schubladen mit drei Seiten aus Eloxaluminium, Boden veredelt in silbergrau

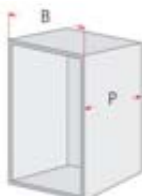

CODICE ARTICOLO/ARTICLE CODE CODE ARTICLE/CÓDIGO DEL ARTÍCULO ARTIKELNUMMER	B mm	P mm	H mm	LARGHEZZA VANO / COMPART. WIDTH LARGEUR COMPART./ ANCHURA ESPACIO INT./ BREITE EINSATZ mm
K3 B9 40	400	480	95	360÷368
K3 B9 45	450	480	95	410÷418
K3 B9 60	600	480	95	560÷568
K3 B9 70	700	480	95	660÷668
K3 B9 80	800	480	95	760÷768
K3 B9 90	900	480	95	860÷868
K3 B9 120	1200	480	95	1160÷1168

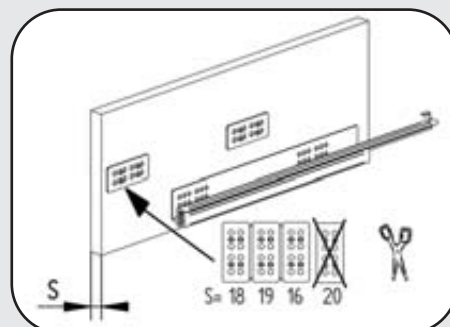

Cassettoni H 190 mm

- Guide con autorientro ammortizzato
- Portata guide: 30 kg
- Cassetto tre lati in alluminio anodizzato con fondo in nobilitato color grigio argento

Deep drawers H 190 mm

- Runners with dampened self-closing mechanism
- Runner capacity: 30 kg
- Drawer with three sides in anodised aluminium with silver-grey coloured metal bottom

Tiroirs profonds H 190 mm

- Glissières à retour automatique amorti
- Portée des glissières: 30 kg
- Tiroir trois côtés en aluminium anodisé avec fond en panneau anoblí couleur gris d'argent

Cajones grandes H 190 mm

- Guías con retorno automático amortiguado
- Capacidad de las guías: 30 kg
- Cajón con tres lados de aluminio anodizado y fondo de tablero atamborado de color plateado

Schubkästen H 190 mm

- Führungsschienen mit gedämpfem Selbststeinzug
- Tragkraft der Führungen: 30 kg
- Schubladen mit drei Seiten aus Eloxaluminium, Boden veredelt in silbergrau

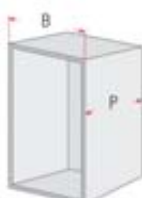

CODICE ARTICOLO/ARTICLE CODE CODE ARTICLE/CÓDIGO DEL ARTÍCULO ARTIKELNUMMER	B mm	P mm	H mm	LARGHEZZA VANO / COMPART. WIDTH LARGEUR COMPART./ ANCHURA ESPACIO INT./ BREITE EINSATZ mm
K3 H19 40	400	480	190	360÷368
K3 H19 45	450	480	190	410÷418
K3 H19 60	600	480	190	560÷568
K3 H19 70	700	480	190	660÷668
K3 H19 80	800	480	190	760÷768
K3 H19 90	900	480	190	860÷868
K3 H19 120	1200	480	190	1160÷1168

- Guide con autorientro ammortizzato
- Portata guide: 50 kg

- Runners with dampened self-closing mechanism
- Runner capacity: 50 kg

- Glissières à retour automatique amorti
- Portée des glissières: 50 kg

- Guías con retorno automático amortiguado
- Capacidad de las guías: 50 kg

- Führungsschienen mit gedämpfem Selbststeinzug
- Tragkraft der Führungen: 50 kg

CODICE ARTICOLO/ARTICLE CODE CODE ARTICLE/CÓDIGO DEL ARTÍCULO ARTIKELNUMMER	B mm	P mm	H mm	LARGHEZZA VANO / COMPART. WIDTH LARGEUR COMPART./ ANCHURA ESPACIO INT./ BREITE EINSATZ mm
K5 H19 90	900	480	190	860÷868
K5 H19 120	1200	480	190	1160÷1168

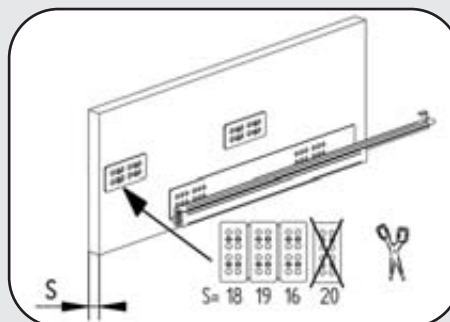

Cassetti sottovasca sagomati H 95 mm

- Guide con autoriento ammortizzato
- Portata guide: 30 kg
- Cassetto sottovasca sagomato tre lati in alluminio anodizzato con fondo in nobilitato color grigio argento

Shaped under-sink drawers H 95 mm

- Runners with dampened self-closing mechanism
- Runner capacity: 30 kg
- Shaped under-sink drawers with three sides in anodised aluminium with silver-grey coloured metal bottom

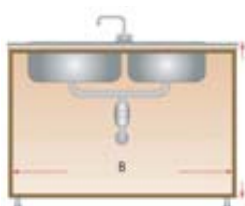

Tiroirs sous évier profilés H 95 mm

- Glissières à retour automatique amorti
- Portée des glissières: 30 kg
- Tiroirs sous évier profilés trois côtés en aluminium anodisé avec fond en panneau anobli couleur gris d'argent

Cajones para debajo del fregadero de madera moldeada H 95 mm

- Guías con retorno automático amortiguado
- Capacidad de las guías: 30 kg
- Cajones para debajo del fregadero de madera moldeada con tres lados de aluminio anodizado y fondo de tablero atamborado de color plateado

Formschubladen Wannenunterschrank H 95 mm

- Führungsschienen mit gedämpftem Selbsteinzug
- Tragkraft der Führungen: 30 kg
- Formschubladen Wannenunterschrank drei Seiten aus Eloxaluminium, Boden veredelt in silbergrau

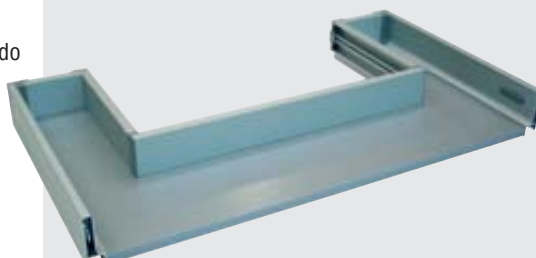

CODICE ARTICOLO/ARTICLE CODE CODE ARTICLE/CÓDIGO DEL ARTÍCULO ARTIKELNUMMER	B mm	P mm	H mm	LARGHEZZA VANO/COMPART. WIDTH LARGEUR COMPART./ANCHURA ESPACIO INT./BREITE EINSATZ mm
K3 SVB9 80	800	480	95	760÷768
K3 SVB9 90	900	480	95	860÷868
K3 SVB9 120	1200	480	95	1160÷1168

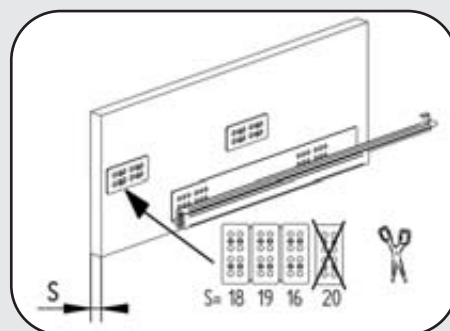

Vassoi interni H 50 mm

- Guide con autoriento ammortizzato
- Portata guide: 30 kg
- Cassetto quattro lati in alluminio anodizzato con fondo in nobilitato color grigio argento.

Internal trays H 50 mm

- Runners with dampened self-closing mechanism
- Runner capacity: 30 kg
- Drawer with four sides in anodised aluminium with silver-grey coloured metal bottom.

Plateaux internes H 50 mm

- Glissières à retour automatique amorti
- Portée des glissières: 30 kg
- Tiroir quatre côtés en aluminium anodisé avec fond en panneau anobli couleur gris d'argent

Bandejas internas H 50 mm

- Guías con retorno automático amortiguado
- Capacidad de las guías: 30 kg
- Cajón con cuatro lados de aluminio anodizado y fondo de tablero atamborado de color plateado

Interne Ablagen H 50 mm

- Führungsschienen mit gedämpftem Selbsteinzug
- Tragkraft der Führungen: 30 kg
- Schubladen mit vier Seiten aus Eloxaluminium, Boden veredelt in silbergrau



CODICE ARTICOLO/ARTICLE CODE CODE ARTICLE/CÓDIGO DEL ARTÍCULO ARTIKELNUMMER	B mm	P mm	H mm	LARGHEZZA VANO/COMPART. WIDTH LARGEUR COMPART./ANCHURA ESPACIO INT./BREITE EINSATZ mm
K3 V5 60	600	480	50	560÷568
K3 V5 70	700	480	50	660÷668
K3 V5 80	800	480	50	760÷768
K3 V5 90	900	480	50	860÷868
K3 V5 120	1200	480	50	1160÷1168

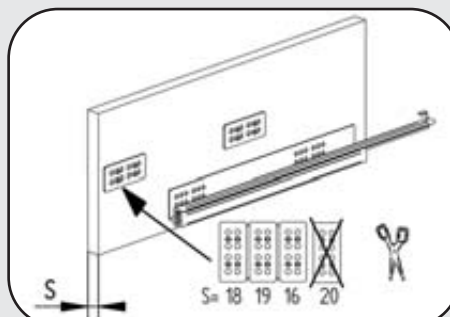
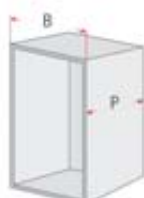

Profilo frontale in alluminio per cassetti interni H 95 mm fornito in barre da mm 3000

Perfil frontal de aluminio para cajones interiores H 95 mm con barras de 3.000 mm

Aluminium front profile for internal drawers H 95 mm supplied in 3000 mm bars

Frontprofil aus Aluminium für interne Schubladen H 95 mm, geliefert in Stangen mit mm 3000

Profil de façade en aluminium pour tiroirs internes H 95 mm fourni en barre de 3000 mm

CODICE ARTICOLO/ARTICLE CODE CODE ARTICLE/CÓDIGO DEL ARTÍCULO ARTIKELNUMMER	H mm	BARRA mm/BAR mm BARRE mm/BARRA mm STANGE mm
CD FB 3	103	3000



Profilo frontale in alluminio per cassettoni interni H 190 mm fornito in barre da mm 3000

Perfil frontal de aluminio para cajones grandes interiores H 190 mm con barras de 3.000 mm

Aluminium front profile for internal deep drawers H 190 mm supplied in 3000 mm

Frontprofil aus Aluminium für interne Schubkästen H 190 mm, geliefert in Stangen mit mm 3000

Profil de façade en aluminium pour tiroirs profonds internes H 95 mm fourni en barre de 3000 mm

CODICE ARTICOLO/ARTICLE CODE CODE ARTICLE/CÓDIGO DEL ARTÍCULO ARTIKELNUMMER	H mm	BARRA mm/BAR mm BARRE mm/BARRA mm STANGE mm
CD FA 3	198	3000



Accessori per frontale H 95 mm

- Kit tappi e fissaggi in plastica per profilo frontale H 95 mm

Accessories for front H 95 mm

- Plastic Stopper and attachment kit for front H 95 mm

Accessoires pour façade H 95 mm

- Kit bouchons et fixations en plastique façade H 95 mm

Accesorios para frontal H 95 mm

- Kit tapones y fijaciones de plástico para frontal H 95

Zubehör für Frontteil H 95 mm

- Kit Abdeckungen und Befestigungen aus Kunststoff für Frontteil H 95 mm

CODICE ARTICOLO/ARTICLE CODE
CODE ARTICLE/CÓDIGO DEL ARTICULO
ARTIKELNUMMER

CD TFB

Accessori per frontale H 190 mm

- Kit tappi e fissaggi in plastica per profilo frontale H 190 mm

Accessories for front H 190 mm

- Plastic Stopper and attachment kit for front H 190 mm

Accessoires pour façade H 190 mm

- Kit bouchons et fixations en plastique façade H 190 mm

Accesorios para frontal H 190 mm

- Kit tapones y fijaciones de plástico para frontal H 190

Zubehör für Frontteil H 190 mm

- Kit Abdeckungen und Befestigungen aus Kunststoff für Frontteil H 190 mm

CODICE ARTICOLO/ARTICLE CODE
CODE ARTICLE/CÓDIGO DEL ARTICULO
ARTIKELNUMMER

CD TFA

Accessori per frontali

- Dima di posizionamento per aggancio anta

Accessories for fronts

- Positioning template to attach flap

Accessoires pour façades

- Gabarit de positionnement pour accrochage porte

Accesorios para frontales

- Plantilla de colocación para enganche de la hoja

Zubehör für Frontteil

- Positionierschablone für das Einhängen der Tür

CODICE ARTICOLO/ARTICLE CODE
CODE ARTICLE/CÓDIGO DEL ARTICULO
ARTIKELNUMMER

CD T32

